

## RIPS® P500 ROTARY SENSOR

High-resolution angle feedback for industrial and scientific application

- **Non-contacting inductive technology to eliminate wear**
- **Angle set to customer's requirement**
- **Compact, durable and reliable**
- **High accuracy and stability**
- **Sealing to IP65/IP67 as required**



As a leading designer and manufacturer of linear, rotary, tilt and intrinsically safe position sensors, Positek® has the expertise to supply a sensor to suit a wide variety of applications.

Our P500 RIPS® (Rotary Inductive Position Sensor) is an affordable, durable, high-accuracy rotary sensor designed for industrial and scientific feedback applications.

The P500, like all Positek® sensors, is supplied with the output calibrated to the angle required by the customer, between 16 and 160 degrees and with full EMC protection built in. The sensor provides a linear output proportional with input shaft rotation. There is a machined registration mark to identify the calibrated mid point.

It is particularly suitable for OEMs seeking good sensor performance for arduous applications such as industrial machinery where cost is important.

Overall performance, repeatability and stability are outstanding over a wide temperature range. The P500 has long service life and environmental resistance with a rugged stainless steel body and shaft, the flange and servo mounts are anodised aluminium. The flange or servo mounting options make the sensor easy to install, it also offers a range of mechanical and electrical options. Environmental sealing is to IP65 or IP67 depending on selected cable or connector options.

### SPECIFICATION

<b>Dimensions</b>	
Body diameter	35 mm
Body Length (to seal face)	44 mm standard, 50 mm buffered
Shaft	15 mm Ø 6 mm
For full mechanical details see drawing P500-11	
<b>Independent Linearity</b>	≤ ± 0.25% FSO @ 20°C - up to 100° ≤ ± 0.1% FSO @ 20°C* available upon request.
*Sensors with calibrated travel up to 100°.	
<b>Temperature Coefficients</b>	< ± 0.01%/°C Gain & < ± 0.01%FS/°C Offset
<b>Frequency response</b>	> 10 kHz (-3dB) > 300 Hz (-3dB) 2 wire 4 to 20 mA
<b>Resolution</b>	Infinite
<b>Noise</b>	< 0.02% FSO
<b>Torque</b>	< 20 mNm Static
<b>Environmental Temperature Limits</b>	
Operating	-40°C to +125°C standard -20°C to +85°C buffered -40°C to +125°C
Storage	-40°C to +125°C
<b>Sealing</b>	IP65/IP67 depending on connector / cable option
<b>EMC Performance</b>	EN 61000-6-2, EN 61000-6-3
<b>Vibration</b>	IEC 68-2-6: 10 g
<b>Shock</b>	IEC 68-2-29: 40 g
<b>MTBF</b>	350,000 hrs 40°C Gf
<b>Drawing List</b>	
P500-11	Sensor Outline
Drawings, in AutoCAD® dwg or dxf format, available on request.	

**Do you need a position sensor made to order to suit a particular installation requirement or specification? We'll be happy to modify any of our designs to suit your needs - please contact us with your requirements.**



## RIPS® P500 ROTARY SENSOR

High-resolution angle feedback for industrial and scientific applications

### How Positek's PIPS® technology eliminates wear for longer life

Positek's **PIPS®** technology (Positek Inductive Position Sensor) is a major advance in displacement sensor design. PIPS®-based displacement transducers have the simplicity of a potentiometer with the life of an LVDT/RVDT.

PIPS® technology combines the best in fundamental inductive principles with advanced micro-electronic integrated circuit technology. A PIPS® sensor, based on simple inductive coils using Positek's ASIC control technology, directly measures absolute position giving a DC analogue output signal. Because there is no contact between moving electrical components, reliability is high and wear is eliminated for an exceptionally long life.

PIPS® overcomes the drawbacks of LVDT technology – bulky coils, poor length-to-stroke ratio and the need for special magnetic materials. It requires no separate signal conditioning.

Our LIPS® range are linear sensors, while RIPS® are rotary units and TIPS® are for detecting tilt position. Ask us for a full technical explanation of PIPS® technology.

We also offer a range of ATEX-qualified intrinsically-safe sensors.

### TABLE OF OPTIONS

**CALIBRATED TRAVEL:** Factory-set to any angle from ±8° to ±80° in increments of 1 degree.  
Full 360° Mechanical rotation.

#### ELECTRICAL INTERFACE OPTIONS

OUTPUT SIGNAL	SUPPLY INPUT	OUTPUT LOAD
Standard: 0.5-4.5V dc ratiometric	+5V dc nom. ± 0.5V.	5kΩ min.
Buffered: 0.5-4.5V dc	+24V dc nom. + 9-28V.	5kΩ min.
±5V dc	±15V dc nom. ± 9-28V.	5kΩ min.
0.5-9.5V dc	+24V dc nom. + 13-28V.	5kΩ min.
±10V dc	±15 V dc nom. ± 13.5-28V.	5kΩ min.
Supply Current	10mA typical, 20mA maximum.	
4-20mA (2 wire)	+24 V dc nom. + 18-28V.	300Ω @ 24V.
(3 wire sink)	+24 V dc nom. + 13-28V.	950Ω @ 24V.
(3 wire source)	+24 V dc nom. + 13-28V.	300Ω max.

Sensors supplied with access to output 'zero' and 'span' calibration adjustments as standard. No access option available.

#### CONNECTOR/CABLE OPTIONS

Connector - Hirschmann GD series IP65  
Cable with M12 gland or short gland IP67  
Cable length >50 cm – please specify length in cm

#### MOUNTING OPTIONS

Flange, Servo.

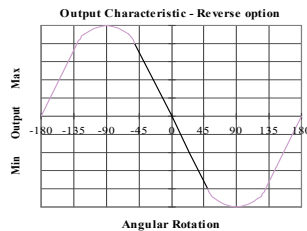
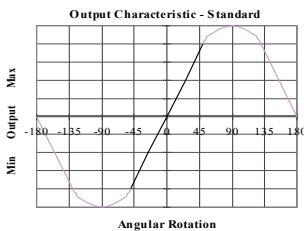

RIPS® SERIES P500 Rotary Sensor

a	b	c	d	e	f	g
---	---	---	---	---	---	---

P500 . Displacement Output Adjustments Connections Option Option Z-code

a Displacement (degrees)		Value
Displacement in degrees	e.g. 0 - 54 degrees	<b>54</b>
b Output		
Supply V dc V <sub>s</sub> (tolerance)	Output	Code
+5V (4.5 - 5.5V)	0.5 - 4.5V (ratiometric with supply)	<b>A</b>
±15V nom. (±9 - 28V)	±5V	<b>B</b>
+24V nom. (13 - 28V)	0.5 - 9.5V	<b>C</b>
±15V nom. (±13.5 - 28V)	±10V	<b>D</b>
+24V nom. (18 - 28V)	4 - 20mA 2 wire	<b>E</b>
+24V nom. (13 - 28V)	4 - 20mA 3 wire Sink	<b>F</b>
+24V nom. (9 - 28V)	0.5 - 4.5V	<b>G</b>
+24V nom. (13 - 28V)	4 - 20mA 3 wire Source	<b>H</b>
c Calibration Adjustments		Code
Accessible - default		blank
Sealed		<b>Y</b>
d Connections Cable* or Connector		Code
Connector	IP65 DIN 43650 'C'	<b>J</b>
Cable Gland	IP67 M12	<b>Lxx</b>
Cable Gland	IP67 Short	<b>Mxx</b>
*Supplied with 50 cm as standard, specify required cable length specified in cm. e.g. L2000 specifies cable gland with 20 metres of cable. Nb: restricted cable pull strength.		
e Shaft Option		Code
None		blank
Sprung to stop	Up to 100° maximum	<b>N</b>
f Sensor Mounting		Code
Flange - default	Aluminium	blank
Servo Mount	Aluminium	<b>P</b>
g Z-code		Code
Connector IP67 M12 IEC 60947-5-2 must have options 'Y' & 'J'		<b>Z600</b>
Connector IP67 M12 IEC 60947-5-2 must have option 'J'		<b>Z601</b>
≤± 0.1% @20°C Independent Linearity displacement up to 100 degrees only!		<b>Z650</b>
Connector with cable option 'J' with length required in cm i.e. J500 specifies connector with 500cm of cable.		<b>Z999</b>



## Installation Information RIPS® P500 ROTARY SENSOR

Output Option	Output Description:	Supply Voltage: $V_s$ (tolerance)	Load resistance: (include leads for 4 to 20mA O/Ps)
<b>A</b>	0.5 - 4.5V (ratiometric with supply)	+5V (4.5 - 5.5V)	$\geq 5k\Omega$
<b>B</b>	$\pm 5V$	$\pm 15V$ nom. ( $\pm 9 - 28V$ )	$\geq 5k\Omega$
<b>C</b>	0.5 - 9.5V	+24V nom. (13 - 28V)	$\geq 5k\Omega$
<b>D</b>	$\pm 10V$	$\pm 15V$ nom. ( $\pm 13.5 - 28V$ )	$\geq 5k\Omega$
<b>E</b>	4 - 20mA 2 wire Current Loop	+24V nom. (18 - 28V)	$\approx 0 - 300\Omega$ max. @24V $\sim 1.2$ to 6V across 300 $\Omega$ $\{R_L \text{ max.} = (V_s - 18) / 20^3\}$
<b>F</b>	4 - 20mA 3 wire Sink	+24V nom. (13 - 28V)	$\approx 0 - 950\Omega$ max. @24V $\sim 3.8$ to 19V across 950 $\Omega$ $\{R_L \text{ max.} = (V_s - 5) / 20^3\}$
<b>G</b>	0.5 - 4.5V	+24V nom. (9 - 28V)	$\geq 5k\Omega$
<b>H</b>	4 - 20mA 3 wire Source	+24V nom. (13 - 28V)	$\approx 0 - 300\Omega$ max. $\sim 1.2$ to 6V across 300 $\Omega$

Not all output options available - see product datasheet for full options list

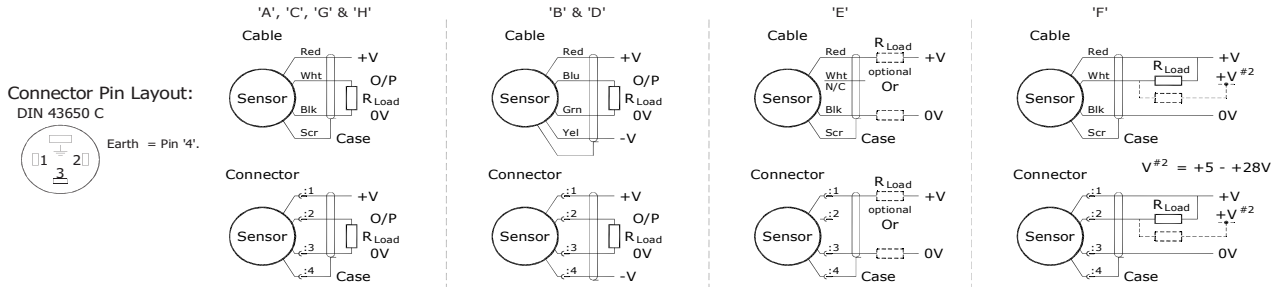

### Gain and Offset Adjustment: (Where accessible - Typically $\pm 10\%$ Min available)

To adjust the gain or offset use a small potentiometer adjuster or screwdriver 2mm across. Do not apply too much force on the potentiometers. The offset is set at mid span at the mid point, within  $\pm 5^\circ$ , of rotation.

**Mechanical Mounting:** Flange mounted or servo mount, with appropriate clips, options. The flange slots are 4.5mm by 30 degrees wide on a 48mm pitch. The sensor should be mounted with minimal axial and radial loading on the shaft for optimum life. It is recommended that the shaft is coupled to the drive using a flexible coupling. Tests indicate that life in excess of 16 million cycles can be achieved with 1kg side and end load.

**Output Characteristic:** The sensor has full rotational freedom and two sectors, 180° apart, over which linear response can be achieved. At the mid point of the calibrated range the output signal will be half full scale deflection, and the flat on the shaft is aligned with the registration mark in the base of the sensor. In the calibrated range the output increases as the shaft is rotated in an anti-clockwise direction viewed from the shaft. The calibrated output is factory set to be between 16 and 160°.

### Incorrect Connection Protection levels:-

- A **Not protected** – the sensor is **not** protected against either reverse polarity or over-voltage. The risk of damage should be minimal where the supply current is limited to less than 50mA.
- B & D Supply leads diode protected. Output must not be taken outside  $\pm 12V$ .
- C & G Supply leads diode protected. Output must not be taken outside 0 to 12V.
- E, F & H Protected against any misconnection within the rated voltage.

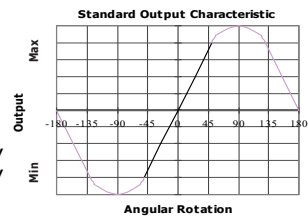
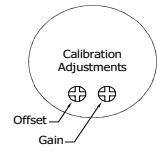

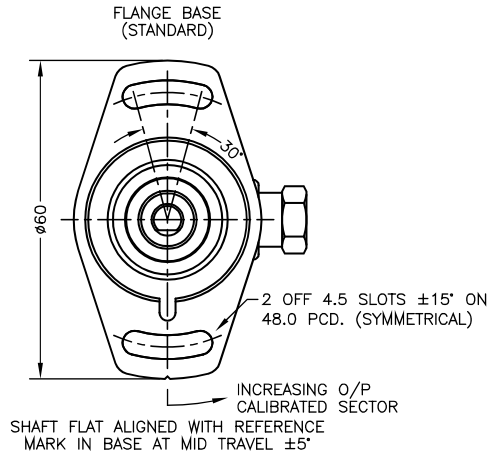
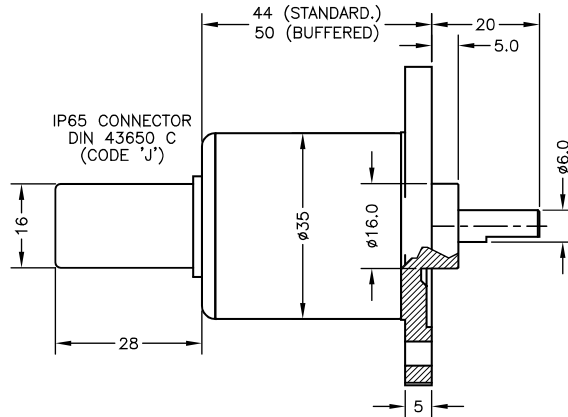
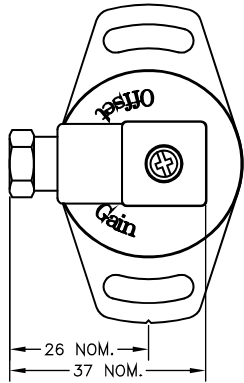

IP67 CABLE GLAND  
(CODE 'Lxx')

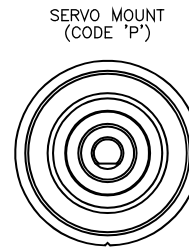
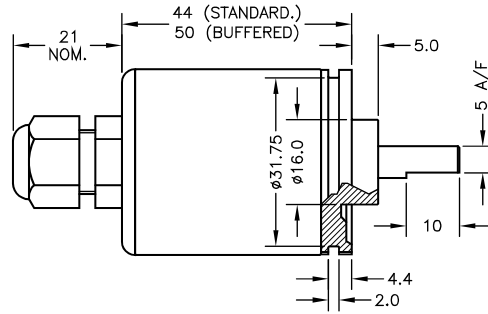

GAIN AND OFFSET ADJUSTMENTS  
SEALED (CODE 'Y')

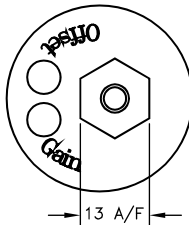

IP67 SHORT CABLE GLAND  
- AXIAL (CODE 'Mxx')

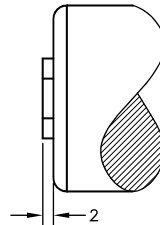

ELECTRICAL OPTIONS/ SPECIFICATIONS

OUTPUT OPTION	OUTPUT	SUPPLY	
A	0.5 TO 4.5V RATIOMETRIC	5V	STANDARD
B	±5V	±15V	
C	0.5 TO 9.5V	24V	
D	±10V	±15V	BUFFERED
E	0.5 TO 4.5V	24V	
F	SUPPLY CURRENT 12mA TYP. 20mA MAX.	24V	
G	4 TO 20mA 2-WIRE	24V	
H	4 TO 20mA 3-WIRE SINK	24V	
	4 TO 20mA 3-WIRE SOURCE	24V	

SINK VERSION OUTPUT COMPLIANCE 5-28V  
SOURCE VERSION DRIVE 300Ω MAX TO 0V

CABLE: 0.2mm<sup>2</sup>, 0/A SCREEN, PUR JACKET - SUPPLIED WITH 50cm OR REQUIRED LENGTH IN cm. e.g. 'L50'

3-CORE: JACKET Ø4mm

4-CORE: JACKET Ø4.6mm

CABLE/CONNECTOR\* CONNECTIONS;

3 CORE 4 CORE CONNECTOR

RED	RED	:1	+Ve
BLACK	GREEN	:3	0V
	YELLOW	:4	-Ve - OPTIONS: B OR D
WHITE	BLUE	:2	OUTPUT
SCREEN	SCREEN	:4	BODY - OPTIONS: A, C, E-H

\*CONNECTORS; MAXIMUM CONDUCTOR CROSS SECTION 0.75mm<sup>2</sup>  
RANGE OF DISPLACEMENT FROM 0-16° TO 0-160° e.g.76°, IN INCREMENTS OF 1°.

BODY MATERIAL:- STAINLESS STEEL.

FLANGE BASE MATERIAL:- ALUMINIUM.

SERVO MOUNT MATERIAL:- ALUMINIUM.

FURTHER OPTIONS:

SPRING RETURN (CODE 'N') AVAILABLE UP TO ±50°

CALIBRATED OUTPUT, PHYSICAL STOPS ±55°

NOTE STANDARD DEVICE HAS NO STOPS.

N	ELEC. OPTIONS AMENDED.	PDM
O	FLANGE THKNNESS ADDED.	PDM
P	ADDITIONAL DIMS/VIEWS ADDED.	PDM
Q	DISP. 16 TO 160° WAS 20 TO 160° RAN442	PDM
R	RANGE NOTE AMENDED ~ RAN1200	PDM



DRAWINGS NOT TO BE CHANGED WITHOUT REFERENCE TO THE CHANGE PROCEDURE.  
CHANGES TO PARTS USED IN INTRINSICALLY SAFE PRODUCT MUST BE APPROVED BY THE AUTHORISED PERSON  
THIS IS AN UNCONTROLLED PRINT AND WILL NOT BE UPDATED.



N	18/10/06	CHECKED BY	X	±0.4
O	05/01/10	RDS	X.X	±0.2
P	06/07/11		X.XX	±0.1
Q	07/11/13	DESCRIPTION		
R	11/09/17	P500 RIPS ROTARY SENSOR		
SCALE	10mm	DRAWING NUMBER	P500-11	REV R
				SHEET 1 OF 1

## RIPS® X500 ROTARY SENSOR INTRINSICALLY SAFE FOR HAZARDOUS GAS/VAPOUR ATMOSPHERES

- **Intrinsically safe for Gas to: Ex II 1G**
- **Non-contacting inductive technology to eliminate wear**
- **Angle set to customer's requirement**
- **Compact, durable and reliable**
- **High accuracy and stability**
- **Sealing to IP65/IP67 as required**



As a leading designer and manufacturer of linear, rotary, tilt and intrinsically safe position sensors, Positek® has the expertise to supply a sensor to suit a wide variety of applications.

Our X500 RIPS® (Rotary Inductive Position Sensor) incorporates electronics system EX07 which is ATEX / IECEx approved for use in potentially explosive **gas/vapour** atmospheres. The X500 is designed for industrial and scientific feedback applications and is ideal for OEMs seeking good sensor performance for arduous applications in hazardous areas. The X500, like all Positek® sensors, is supplied with the output calibrated to the angle required by the customer, between 16 and 160 degrees and with full EMC protection built in. The sensor provides a linear output proportional with input shaft rotation. There is a machined registration mark to identify the calibrated mid point.

Overall performance, repeatability and stability are outstanding over a wide temperature range. The X500 has long service life and environmental resistance with a rugged stainless steel body and shaft. The flange or servo mounting options make the sensor easy to install, it also offers a range of mechanical options. Environmental sealing is to IP65 or IP67 depending on selected cable or connector options.

### SPECIFICATION

<b>Dimensions</b>	
Body diameter	35 mm
Body Length (to seal face)	44 mm
Shaft	15 mm Ø 6 mm
For full mechanical details see drawing X500-11	
<b>Power Supply</b>	+5V dc nom. ± 0.5V, 10mA typ 20mA max
<b>Output Signal</b>	0.5-4.5V dc ratiometric, Load: 5kΩ min.
<b>Independent Linearity</b>	≤ ± 0.25% FSO @ 20°C - up to 100° ≤ ± 0.1% FSO @ 20°C available upon request.
*Sensors with calibrated travel up to 100°.	
<b>Temperature Coefficients</b>	< ± 0.01%/°C Gain & < ± 0.01%FS/°C Offset > 10 kHz (-3dB)
<b>Frequency Response</b>	Infinite
<b>Resolution</b>	< 0.02% FSO
<b>Noise</b>	< 20 mNm Static
<b>Torque</b>	Ex II 1G
<b>Intrinsic Safety</b>	Ex ia IIC T4 Ga (Ta= -40°C to 80°C)
Approval only applies to the specified ambient temperature range and atmospheric conditions in the range 0.80 to 1.10 Bar, oxygen ≤ 21%	
<b>Sensor Input Parameters</b>	Ui: 11.4V, Ii: 0.20A, Pi: 0.51W.
<b>(connector option/s)</b>	Ci: 1.16µF, Li: 50µH
<b>(cable option/s)</b>	Ci: 1.36µF, Li: 860µH with 1km max. cable
<b>Environmental Temperature Limits</b>	
Operating	-40°C to +80°C
Storage	-40°C to +125°C
<b>Sealing</b>	IP65/IP67 depending on connector / cable option
<b>EMC Performance</b>	EN 61000-6-2, EN 61000-6-3
<b>Vibration</b>	IEC 68-2-6: 10 g
<b>Shock</b>	IEC 68-2-29: 40 g
<b>MTBF</b>	350,000 hrs 40°C Gf
<b>Drawing List</b>	
X500-11	Sensor Outline
Drawings, in AutoCAD® dwg or dxf format, available on request.	

**Do you need a position sensor made to order to suit a particular installation requirement or specification? We'll be happy to modify any of our designs to suit your needs - please contact us with your requirements.**



**RIPS® X500 ROTARY SENSOR**  
**INTRINSICALLY SAFE FOR HAZARDOUS GAS/VAPOUR ATMOSPHERES**

Intrinsically safe equipment is defined as "equipment which is incapable of releasing sufficient electrical or thermal energy under normal or abnormal conditions to cause ignition of a specific hazardous atmosphere mixture in its most easily ignited concentration."

ATEX / IECEx approved to;  
Ex II 1G  
Ex ia IIC T4 Ga (Ta = -40°C to +80°C)

Designates the sensor as belonging to; Group II: suitable for all areas **except mining**, Category 1 G: can be used in areas with continuous, long or frequent periods of exposure to hazardous gas (Zone 0).

Protection class ia, denotes intrinsically safe for all zones Apparatus group IIC: suitable for IIA to IIC explosive gas. Temperature class T4: maximum surface temperature under fault conditions 135°C. Ambient temperature range extended to -40°C to +80°C.

It is imperative Positek® intrinsically safe sensors be used in conjunction with a galvanic barrier to meet the requirements of the product certification. The Positek X005 Galvanic Isolation Amplifier is purpose made for Positek IS sensors making it the perfect choice. Refer to the X005 datasheet for product specification and output configuration options.

**Safety Parameters:-**

Ui: 11.4V, Ii: 0.20A, Pi: 0.51W  
Ci = 1.36µF\*      Li = 860µH\* (cable option/s)  
Ci = 1.16µF      Li = 50µH (connector option/s)

\*Figures for 1km cable where: Ci = 200pF/m & Li = 810nH/m

Sensors can be installed with a maximum of 1000m of cable.

Cable characteristics must not exceed:-  
Capacitance: ≤ 200 pF/m for max. total of: 200 nF.  
Inductance: ≤ 810 nH/m for max. total of: 810 µH

For cable lengths exceeding 10 metres a five wire connection is recommended to eliminate errors introduced by cable resistance and associated temperature coefficients.

ATEX / IECEx approved sensors suitable for dust (E series) and mining (M series) applications, are also available from Positek.

**TABLE OF OPTIONS**

**CALIBRATED TRAVEL:** Factory-set to any angle from ±8° to ±80° in increments of 1 degree.  
Full 360° Mechanical rotation.

**ELECTRICAL INTERFACE OPTIONS**

Sensors supplied with access to output 'zero' and 'span' calibration adjustments as standard. No access option available.

The Positek® X005 Galvanic Isolation Amplifier is available with the following output options;  
Standard: 0.5 - 9.5V or 4 - 20mA.  
Reverse: 9.5 - 0.5V or 20 - 4mA.

**CONNECTOR/CABLE OPTIONS**

Connector - Hirschmann GD series IP65  
Cable<sup>1</sup> with M12 gland or short gland IP67

<sup>1</sup>Three core (black jacket) or five core (blue jacket) cable options available. Cable length >50 cm – please specify length in cm up to 15000 cm max.

We recommend all customers refer to the 3 or 5-Wire Mode Connection page.

**MOUNTING OPTIONS**

Flange, Servo.

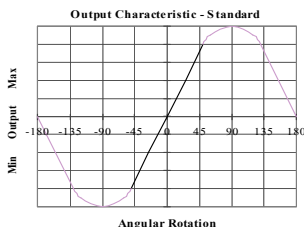



## Three or Five-Wire Mode Connection FOR INTRINSICALLY SAFE SENSORS IN HAZARDOUS ATMOSPHERES

The aim of this document is to help readers who do not understand what is meant by three or five wire modes of connection between the galvanic isolation amplifier and sensor, and the factors behind them. It is by no means an in-depth technical analysis of the subject.

Whether opting for a pre-wired Positek® Intrinsicly Safe sensor or one with a connector, choosing the right mode of connection and cable to suit the application requires careful consideration.

Interconnecting cables are not perfect conductors and offer resistance to current flow, the magnitude of resistance<sup>†</sup> depends on conductors resistivity, which changes with temperature, cross sectional area<sup>‡</sup> and length. If the voltage were to be measured at both ends of a length of wire it would be found they are different, this is known as volts drop. Volts drop changes with current flow and can be calculated using Ohm's law, it should be noted that volts drop occurs in both positive and negative conductors. The effects of volts drop can be reduced by increasing the conductors cross sectional area, this does not however eliminate the effects due to temperature variation. There are instances where large cross-section cables are not practical; for example most standard industrial connectors of the type used for sensors have a maximum conductor capacity of 0.75mm<sup>2</sup>, copper prices and ease of installation are other considerations.

This is important because the effects of volts drop can significantly alter the perceived accuracy of the sensor which is ratiometric i.e. the output signal is directly affected by the voltage across the sensor. Changes in temperature will also be seen as gain variation in the sensor output.

**Three wire mode** connections are common and are suitable in most cases with short or moderate cable runs. Applications that do not require a high degree of accuracy but have cable runs, say in excess of 10m, volts drop can be reduced by introducing a terminal box close to the sensor and using a larger cross-section cable for a majority of the cable run. Sensors supplied with three core cable are calibrated with the cable fitted which largely eliminates errors due to conductor resistance at room temperature however, as mentioned above, small gain errors due to temperature fluctuations should be expected.

**Five wire mode** connections have significant benefits as losses in the positive and negative conductors are compensated for by the galvanic isolation amplifier which can 'sense' the voltage across the sensor and dynamically adjust the output voltage so that the voltage across the sensor is correct. The effects of cable resistance and associated temperature coefficients are eliminated allowing for smaller conductors than a three wire connection for the same cable run. The amplifier can compensate for up to 15Ω per conductor with a current flow of 15mA, which is more than adequate for 150m of 0.25 mm<sup>2</sup> cable, longer lengths will require larger conductors.

**For this reason Positek® recommends five wire connections for cable lengths exceeding 10 metres in 0.25 mm<sup>2</sup> cable to preserve the full accuracy of the sensor.**

See illustrations below for examples of connecting a sensor to the galvanic isolation amplifier.

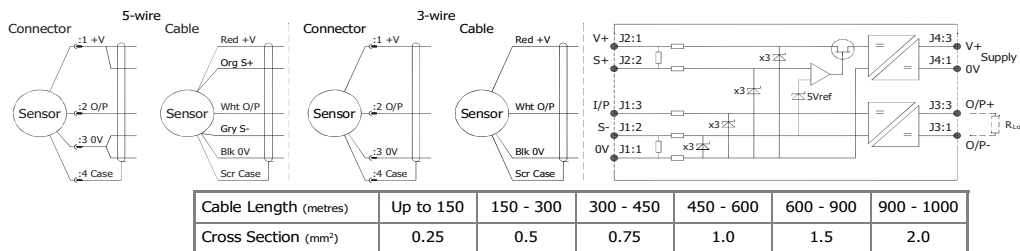

The table above shows recommended conductor sizes with respect to cable length for both three and five wire connections, based on copper conductors. Three wire connections will introduce a gain reduction of 5% and a ±1% temperature dependence of gain over the range -40°C to +80°C for the cable temperature. (i.e. about -150 ppm/°C for the maximum lengths shown and less pro rata for shorter lengths.)

It should be noted that the maximum cable length, as specified in the sensor certification, takes **precedence** and **must not** be exceeded.

Positek® sensors are supplied with three core 0.25 mm<sup>2</sup> cable as standard, however five core 0.25 mm<sup>2</sup> cable can be supplied on request. The galvanic isolation amplifier is available as;

G005-\*\*\* for 'G' and 'H' prefix sensors  
X005-\*\*\* for 'E', 'M' and 'X' prefix sensors

<sup>†</sup>  $R = \rho L / A$   $\rho$  is the resistivity of the conductor ( $\Omega m$ )  $L$  is the length of conductor (m)  $A$  is the conductor cross-sectional area (m<sup>2</sup>).

<sup>‡</sup> It is presumed that direct current flow is uniform across the cross-section of the wire, the galvanic isolation amplifier and sensor are a dc system.



**Intrinsically Safe - Gas/Vapour Atmospheres**  
RIPS® SERIES X500 Rotary Sensor

a	b	c	d	e	f	g	
X500	. Displacement	A	Adjustments	Connections	Option	Option	Z-code

a Displacement (degrees)	Value	
Displacement in degrees e.g. 0 - 54 degrees	<b>54</b>	
b Output	Code	
Supply V dc V <sub>s</sub> (tolerance)	Output	Code
+5V (4.5 - 5.5V)	0.5 - 4.5V (ratiometric with supply)	<b>A</b>
c Calibration Adjustments	Code	
Accessible - default	blank	
Sealed	<b>Y</b>	
d Connections Cable* or Connector	Code	
Connector	IP65 DIN 43650 'C'	<b>J</b>
Cable Gland	IP67 M12 - 3-core cable	<b>Lxx</b>
Cable Gland	IP67 M12 - 5-core cable	<b>LQxx</b>
Cable Gland	IP67 Short - 3-core cable	<b>Mxx</b>
Cable Gland	IP67 Short - 5-core cable	<b>MQxx</b>
<small>*Supplied with 50 cm as standard, specify required cable length specified in cm. e.g. L2000 specifies cable gland with 20 metres of cable. Nb: restricted cable pull strength.</small>		
e Shaft Option	Code	
None	blank	
Sprung to stop	Up to 100° maximum	<b>N</b>
f Sensor Mounting	Code	
Flange - default	Stainless Steel	blank
Servo Mount	Stainless Steel	<b>P</b>
g Z-code	Code	
Calibration to suit X005 - Default	<b>Z000</b>	
Connector IP67 M12 IEC 60947-5-2 must have options 'Y' & 'J'	<b>Z600</b>	
Connector IP67 M12 IEC 60947-5-2 must have option 'J'	<b>Z601</b>	
± 0.1% @20°C Independent Linearity displacement up to 100 degrees only!	<b>Z650</b>	
Connector with cable option 'J' or 'JQ' with length required in cm i.e. J500 specifies connector with 500cm of cable.	<b>Z999</b>	

**Note!**

All Intrinsically Safe (IS) sensors must have a Z-code suffix.  
IS sensors must be used in conjunction with a Galvanic Isolation Amplifier - See X005 for Output options.



## Installation Information RIPS® X500 ROTARY SENSOR INTRINSICALLY SAFE FOR HAZARDOUS GAS/VAPOUR ATMOSPHERES

For certificate number and safety parameters information for product marked EX04, see next page.

ATEX /IECEX Qualified to Intrinsic Safety Standard Certificate numbers SIRA 13ATEX2371X IECEX SIR 13.0154X		Ex II 1G Ex ia IIC T4 Ga (Ta = -40°C to +80°C)	
Electronics Version	Output Description:	Supply Voltage: $V_s$ (tolerance)	Load resistance:
EX07	0.5 - 4.5V (ratiometric with supply) [Output code 'A']	+5V (4.5 - 5.5V)	5kΩ min

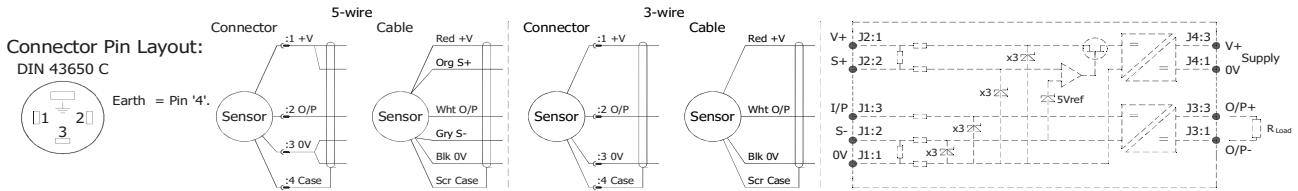

**Putting Into Service:** The sensor must be used with a galvanic isolation barrier designed to supply the sensor with a nominal 5V and to transmit the sensor output to a safe area. The barrier parameters must not exceed:-

**U<sub>i</sub> = 11.4V**      **I<sub>i</sub> = 0.20A**      **P<sub>i</sub> = 0.51W**  
**C<sub>i</sub> = 1.36µF\***      **L<sub>i</sub> = 860µH\***      (\*'Lxx', 'LQxx', 'Mxx' or 'MQxx' options) \*Figures for 1km cable  
**C<sub>i</sub> = 1.16µF**      **L<sub>i</sub> = 50µH**      (\*'J' option)

The sensor is certified to be used with up to **1000m** of cable, cable characteristics must not exceed:-

Capacitance: ≤ 200 pF/m for max. total of: 200 nF  
 Inductance: ≤ 810 nH/m for max. total of: 810 µH

Approval only applies to specified ambient temperature range and atmospheric conditions in the range: 0.80 to 1.10 Bar, oxygen ≤ 21%.

The performance of the sensor may be affected by voltage drops associated with long cable lengths; For cable lengths exceeding 10 metres a five wire connection is recommended to eliminate errors introduced by cable resistance and associated temperature coefficients.

N.b. sensors supplied with cable, the free end must be appropriately terminated.

**Special Condition for Safe Use:**

The apparatus does not meet the 500 V r.m.s dielectric strength test between circuit and frame, in accordance with clause 6.3.13 of IEC 60079-11:2011. This must be taken into consideration on installation.

When using a Sensor that has an integral cable in a dust application, the free end of the cable shall be appropriately terminated for the zone of use.

Under certain extreme circumstances, the non-metallic and isolated metal parts incorporated in the enclosure of this equipment may generate an ignition-capable level of electrostatic charge. Therefore the equipment shall not be installed in a location where the external conditions are conducive to the build-up of electrostatic charge on such surfaces. This is particularly important if the equipment is installed in a zone 0 location. In addition, the equipment shall only be cleaned with a damp cloth.

**Use:** The sensor is designed to measure rotary displacement and provide an analogue output signal.

**Assembly and Dismantling:** The unit is not to be serviced or dismantled and re-assembled by the user.

**Maintenance:** No maintenance is required. Any cleaning must be done with a damp cloth.

**Gain and Offset Adjustment:** (Where accessible - Typically ± 10% Min available)  
 To adjust the gain or offset use a small potentiometer adjuster or screwdriver 2mm across. Do not apply too much force on the potentiometers.

**Mechanical Mounting:** Flange mounted or servo mount, with appropriate clips, options. The flange slots are 4.5 mm by 30 degrees wide on a 48 mm pitch. The sensor should be mounted with minimal axial and radial loading on the shaft for optimum life. It is recommended that the shaft is coupled to the drive using a flexible coupling. Tests indicate that life in excess of 16 million cycles can be achieved with 1kg side and end load.

**Output Characteristic:** The sensor has full rotational freedom and two sectors, 180° apart, over which linear response can be achieved. At the mid point of the calibrated range the output signal will be half full scale deflection, and the flat on the shaft is aligned with the registration mark in the base of the sensor. In the calibrated range the output increases as the shaft is rotated in an anti-clockwise direction viewed from the shaft. The calibrated output is factory set to be between 16° and 160°.

**Incorrect Connection Protection levels: Not protected** – the sensor is **not** protected against either reverse polarity or over-voltage. The risk of damage should be minimal where the supply current is limited to less than 50mA.

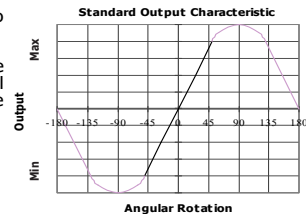
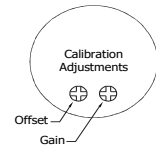



**Installation Information**  
**RIPS® X500 ROTARY SENSOR**  
**INTRINSICALLY SAFE FOR HAZARDOUS GAS/VAPOUR ATMOSPHERES**

For certificate number and safety parameters information for product marked EX07, see previous page.

ATEX Qualified to Intrinsic Safety Standard Certificate numbers SIRA 00ATEX2076X		Ex II 1G EEx ia IIC T4 (Ta = -40°C to +80°C)	
Electronics Version	Output Description:	Supply Voltage: Vs (tolerance)	Load resistance:
EX04	0.5 - 4.5V (ratiometric with supply) [Output code 'A']	+5V (4.5 - 5.5V)	5kΩ min

The barrier parameters must not exceed:-

**Ui = 11.4V**      **Ii = 0.20A**      **Pi = 0.51W**  
**Ci = 1.36µF\***    **Li = 710µH\*** (‘Lxx’ or ‘Mxx’ options) \*Figures for 1km cable  
**Ci = 1.16µF**      **Li = 50µH** (‘J’ option)

The sensor is certified to be used with up to **1000m** of cable, cable characteristics must not exceed:-

Capacitance: ≤ 200 pF/m for max. total of: 200 nF  
 Inductance: ≤ 660 nH/m for max. total of: 660 µH

With the exception of the certificate number and safety parameters above, all other notes regarding Putting Into Service, Use, Assembly and Dismantling etc. on previous page apply to sensors marked EX04 or EX07.

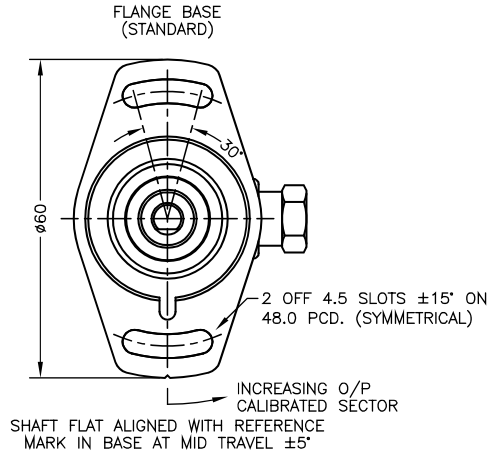
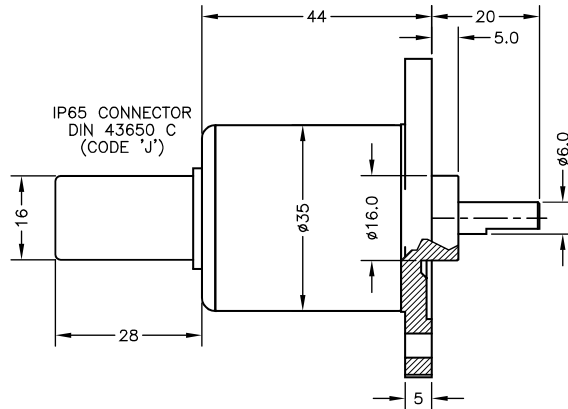
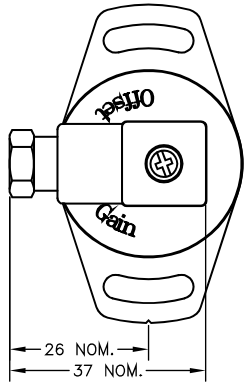

**ELECTRICAL OPTIONS/ SPECIFICATIONS**

**OUTPUT SUPPLY**  
 0.5 TO 4.5V RATIOMETRIC 5V  
 SUPPLY CURRENT 12mA TYP. 20mA MAX.  
 CABLE: 0.2mm<sup>2</sup>, 0/A SCREEN, PUR JACKET - SUPPLIED WITH 50cm OR REQUIRED LENGTH IN cm (1500cm MAX).  
 STANDARD 3-CORE: JACKET Ø4mm BLACK e.g. 'L50'  
 OPTIONAL 5-CORE: JACKET Ø4.6mm BLUE e.g. 'LQ50'  
**CABLE/CONNECTOR\* CONNECTIONS;**  
 3 CORE 5 CORE CONNECTOR  
 RED RED :1 +Ve  
 - ORG :1 +SENSE (5-WIRE ONLY)  
 BLACK BLACK :3 0V  
 - GRV :3 -SENSE (5-WIRE ONLY)  
 WHITE WHITE :2 OUTPUT  
 SCREEN SCREEN :4 BODY

\*CONNECTORS; MAXIMUM CONDUCTOR CROSS SECTION 0.75mm<sup>2</sup>  
 RANGE OF DISPLACEMENT FROM 0-16° TO 0-160° e.g.76°, IN INCREMENTS OF 1°.  
 BODY MATERIAL:- STAINLESS STEEL.  
 FLANGE BASE MATERIAL:- STAINLESS STEEL.  
 SERVO MOUNT MATERIAL:- STAINLESS STEEL.  
**FURTHER OPTIONS:**  
 SPRING RETURN (CODE 'N') AVAILABLE UP TO ±50°  
 CALIBRATED OUTPUT, PHYSICAL STOPS ±55°  
 NOTE STANDARD DEVICE HAS NO STOPS.

IP67 CABLE GLAND (CODE 'Lxx'/'LQxx')

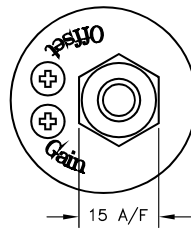
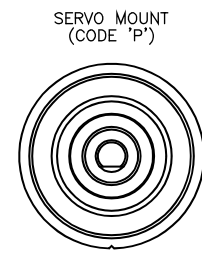
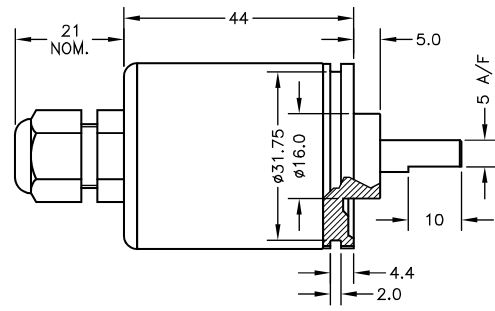

GAIN AND OFFSET ADJUSTMENTS SEALED (CODE 'Y')

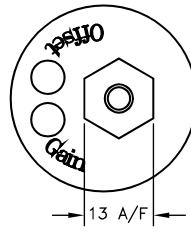

IP67 SHORT CABLE GLAND - AXIAL (CODE 'Mxx'/'MQxx')

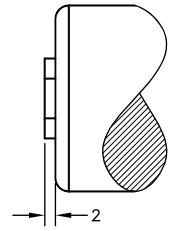

NOTE:- READ INSTALLATION SHEET X500-19 FOR FULL INSTRUCTIONS FOR USE.

ATEX / IECEx APPROVED TO  
 II 1G  
 Ex ia IIC T4 Ga (Ta= -40° to +80°C)  
 Ui 11.4V, Ii 0.2A, Pi 0.51W

APPROVED FOR USE IN CONJUNCTION WITH A GALVANICALLY ISOLATED BARRIER.  
 NOTE: APPROVAL ONLY APPLIES AT NORMAL ATMOSPHERIC PRESSURE!

E	li 0.2A WAS 0.46A - RAN266	PDM
F	ADDITIONAL DIMS/VIEWS ADDED.	PDM
G	DISP. 16 TO 160° WAS 20 TO 160° RAN442	PDM
H	APPROVAL STANDARDS UPDATED - RAN465.	PDM
J	5-CORE OPTION ADDED ~ RAN1102	PDM
K	RANGE NOTE AMENDED ~ RAN1200	PDM



DRAWINGS NOT TO BE CHANGED WITHOUT REFERENCE TO THE CHANGE PROCEDURE.  
 CHANGES TO PARTS USED IN INTRINSICALLY SAFE PRODUCT MUST BE APPROVED BY THE AUTHORISED PERSON  
 THIS IS AN UNCONTROLLED PRINT AND WILL NOT BE UPDATED.



E	21/04/10		CHECKED BY	X	±0.4
F	06/07/11		RDS	X.X	±0.2
G	07/11/13			X.XX	±0.1
					DIMS mm
H	11/03/14	DESCRIPTION			
J	27/04/17	X500 INTRINSICALLY SAFE			
K	11/09/17	ROTARY SENSOR			
SCALE		DRAWING NUMBER		REV	
10mm		X500-11		K	
				SHEET 1 OF 1	