



PM INSTRUMENTATION
59 rue Emile Deschanel,
92400 Courbevoie, France
Tel : 01 46 91 93 30
Fax : 01 46 91 93 39
Web : www.pm-instrumentation.com

TRACKER 280 SERIES

Digital Panel Indicator for Frequency, Timing,
Counting, Batching, Rate, Measurement and Display



A Universal Dual Input Channel Panel Indicator for Pulse,
TTL, AC, Contact Closure and Encoder Signals

TRACKER 280 SERIES INDICATORS

- Dual Universal Input**
- Standard 1/8th DIN size
- Transducer Supplies**
- Bright Six Digit Display
- Isolated Analogue Output**
- User Scaling For Frequency and Pulses
- User Definable Panel Buttons Functions**
- Serial Communications**
- IP65 Front Panel
- Universal Mains Power Input**
- Easy Stock Holding
- Up to 4 Alarm / Batch Control Outputs**
- Totalisation to 12 Digits
- User Definable Logic Inputs**
- 24 VDC / AC Power Supply**

OPTIONS

- Green Display**

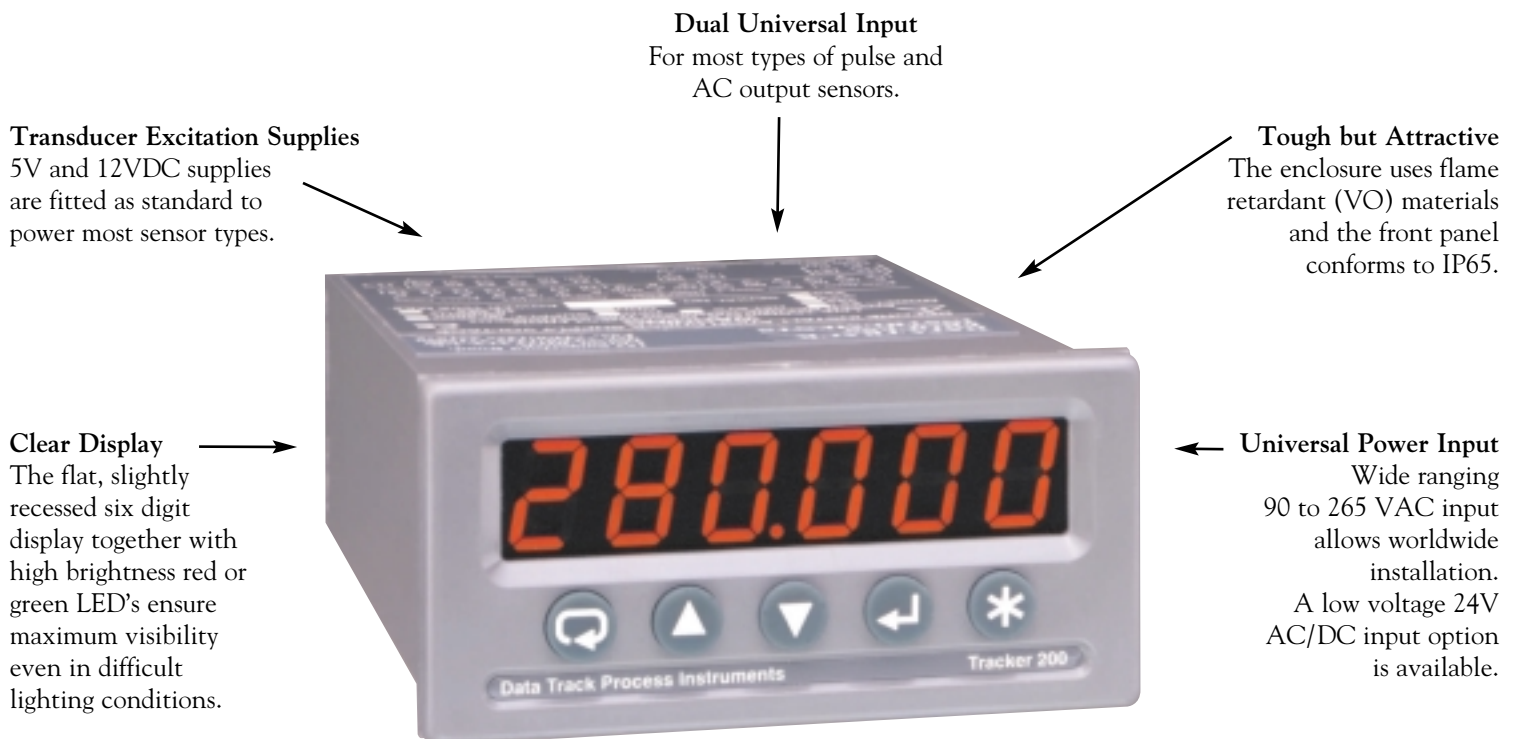

Dual Universal Input
For most types of pulse and AC output sensors.

Transducer Excitation Supplies
5V and 12VDC supplies are fitted as standard to power most sensor types.

Clear Display
The flat, slightly recessed six digit display together with high brightness red or green LED's ensure maximum visibility even in difficult lighting conditions.

Tough but Attractive
The enclosure uses flame retardant (VO) materials and the front panel conforms to IP65.

Universal Power Input
Wide ranging 90 to 265 VAC input allows worldwide installation. A low voltage 24V AC/DC input option is available.

The Tracker 280 series of indicators are designed for demanding industrial applications for use with sensors that give AC or pulse outputs. The Tracker 280 Series can be used for measurement and display only applications or can act as a transmitter using the analogue output. The alarm option allows the Tracker 280 to be used as an alarm trip or batch controller. The unit is fitted with a serial communication interface as standard allowing it to be used as a front end device for PC based systems. The combination of the dual universal inputs together with the power and flexibility of the software allows customers and distributors to reduce stock and spares inventory to a minimum. The Tracker 280 series are styled to match other indicators in the Tracker 200 range.

Applications include:

Pulse totalisation - Pulses are scaled to engineering units.
Pulse rate - Scaled pulses for rate (e.g. litres per minute)
Frequency measurement - Scalable for rate (e.g. rpm)
Up/Down counting

Batch control
Position measurement with encoders
Encoder quadrature measurement
General timing



Tracker 280 series of indicators have been tested and comply with the European Electromagnetic Compatibility Directives and safety requirements. The units are CE marked.

TRACKER 280 APPLICATIONS

Two Channel Counting

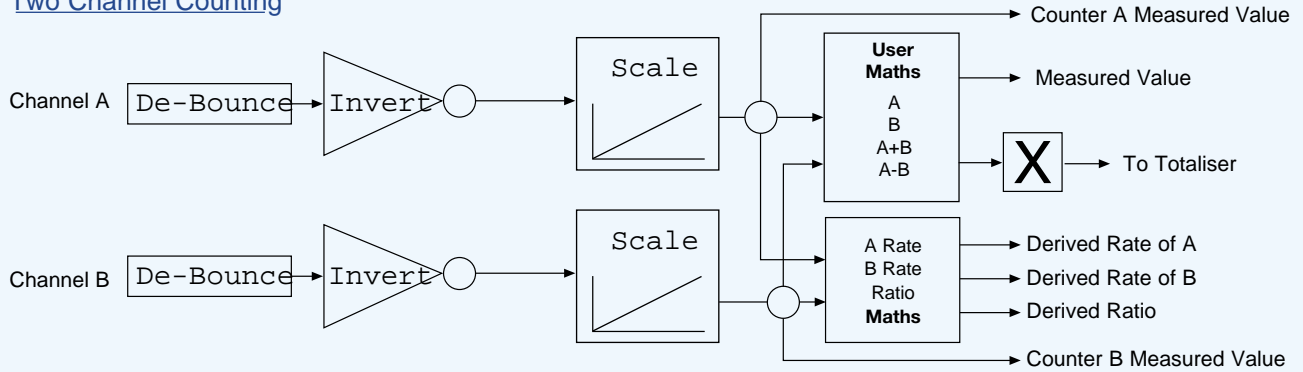

Counting on Channel A, Direction Controlled by the State (or Phase for Encoder) of channel B

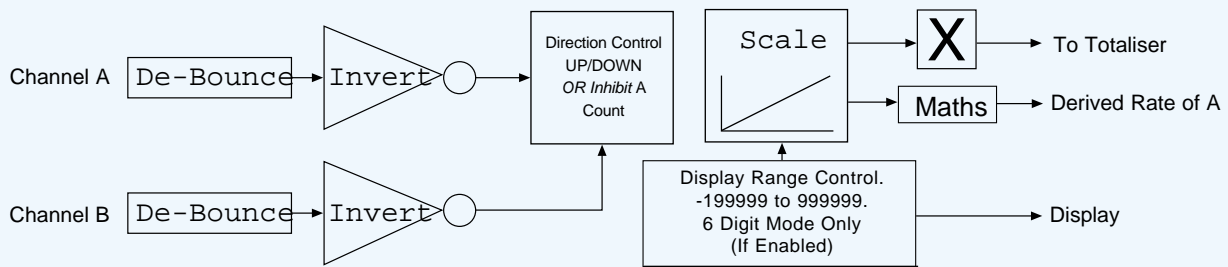

Dual Channel Frequency Measurement

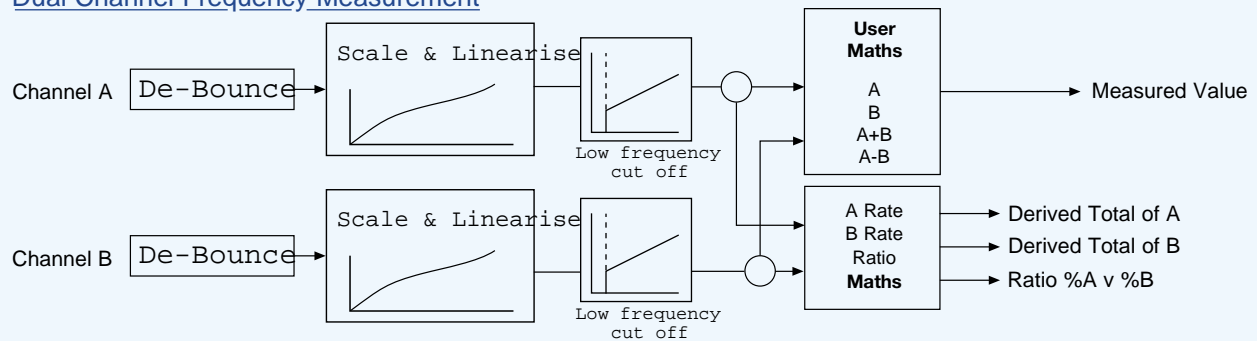

Timing of Period, Pulses and Cumulative Time

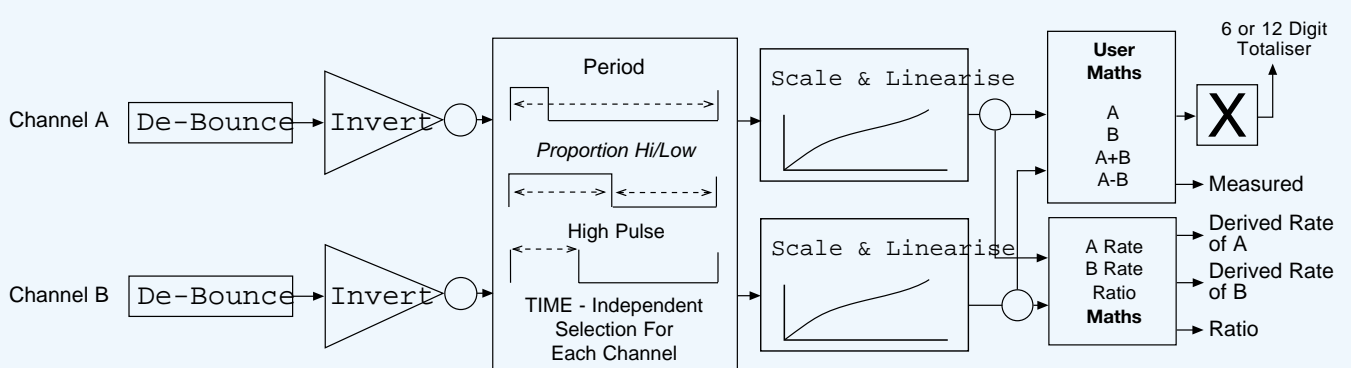

Timing of Edges between Channel A and B

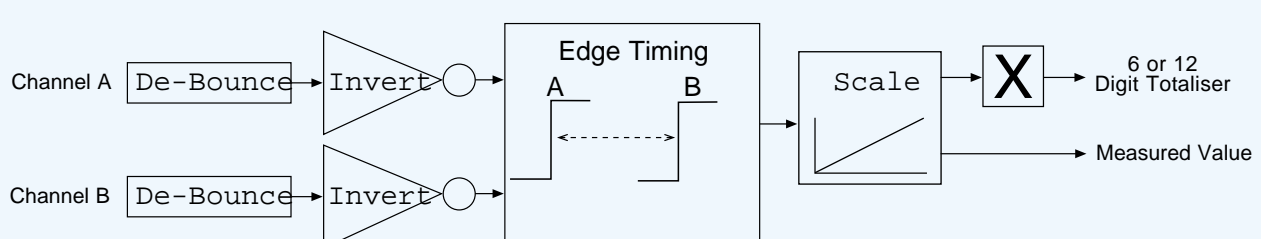

TRACKER 280 APPLICATIONS

Functions

De-Bounce

De-bounce is normally turned off for all sensor types except contact closure. This feature inhibits multiple counts which can be caused by contact bounce, and is selectable between 1 and 255 milliseconds in 1 millisecond steps.

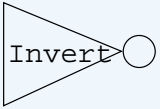

Allows the input signal to be inverted.

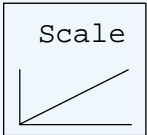

Allows the input count, frequency or time to be converted into engineering units. Scale and Linearise also allows an eight-point user linearisation to be applied to compensate for non-linear sensor output signal rates e.g. turbine flow meters.

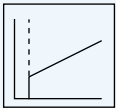

Low frequency cut off. This allows low input frequencies to be regarded as zero (user adjustable).



Pre-Scaler for totalising values. This allows the totalled values to be in different engineering units, or at a different resolution, from the real time measured value.

Batch Counter Control Functions

The Batch Controller functions are used for controlling batching type applications. The user can select from the following control modes:

- Mode 1** On trigger, output 1 & 2 are turned OFF - unit counts (in engineering units) from a pre-set 'reset' value. When batch setpoint 1 is reached, output 1 is turned ON - counts continue to be accumulated. When batch setpoint 2 is reached, output 2 is turned ON - counts continue to be accumulated. Unit waits for the next trigger, which must be toggled OFF then ON to reset the batch control.
- Mode 2** On trigger, output 1 & 2 are turned OFF - unit counts (in engineering units) from a pre-set 'reset' value. When batch setpoint 1 is reached, output 1 is turned ON - counts continue to be accumulated. When batch setpoint 2 is reached, O/P 2 is turned ON and O/P 1 OFF - counts continue to be accumulated. Unit waits for the next trigger, which must be toggled OFF then ON to reset the batch control.
- Mode 3** On trigger, output 1 & 2 are turned OFF - unit counts (in engineering units) from a pre-set 'reset' value. When batch setpoint 1 is reached, output 1 is turned ON - counts continue to be accumulated. When batch setpoint 2 is reached, output 2 is turned ON - counts continue to be accumulated. Automatic re-trigger will occur if the trigger state is correct (no need to toggle trigger). Counts continue to be accumulated.
- Mode 4** On trigger, output 1 & 2 are turned OFF - unit counts (in engineering units) from a pre-set 'reset' value. When batch setpoint 1 is reached, output 1 is turned ON - counts continue to be accumulated. When batch setpoint 2 is reached, O/P 2 is turned ON and O/P 1 OFF - counts continue to be accumulated. Automatic re-trigger will occur if the trigger state is correct (no need to toggle trigger). Counts continue to be accumulated.

TRACKER 280 FEATURES

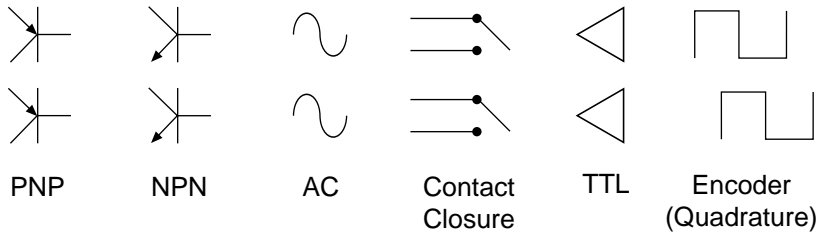

Dual Universal Inputs

The Tracker 280 can be directly connected to most popular process sensors including AC magnetic pickups and pulse output devices. All input types can be scaled to display values in the users preferred engineering units. The user can select to use the internal crystal controlled clock or calibrate to a known external standard. Transducer excitation is provided as standard giving 5 or 12VDC. An 8 point user linearisation can be used to compensate for non-linear sensor outputs for frequency and timing applications. Encoder measurement offers bi-directional pulse counting. A further four times resolution is available when used in quadrature mode.

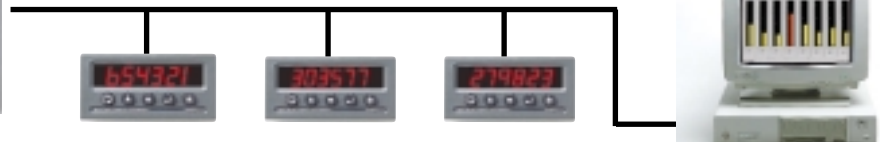

Serial Communications

All Tracker 280 series indicators are supplied with RS422/485 serial communications as standard. This interface allows computer based systems to read values (e.g. the measured value) and write values (e.g. alarm setpoints) to and from the instrument. The Tracker 280 has three protocols including the widely used MODBUS™ RTU (J-BUS).

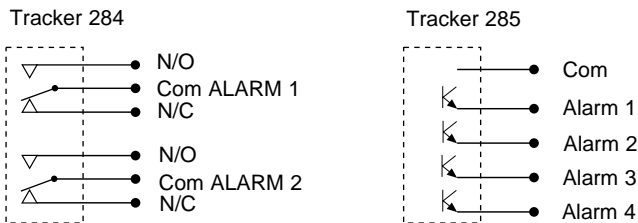

Alarm and Batching Control Outputs (T284 & T285)

The Tracker 284 is fitted with two relay outputs and the Tracker 285 has four TTL outputs. Setpoints can be adjusted at the time of configuration and can be password protected or adjusted using the buttons on the front panel. Each alarm can be used in High, Low or Deviation mode. Outputs can be configured to give a pulse for a user selectable time period, and can be latching with independent delay times for both on and off conditions. In addition they can be set to be energised or de-energised when in the alarm condition or when a batch (count) value is reached.

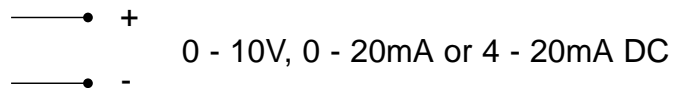

Analogue Output

The measured value can be transmitted as a 0 to 10 Volt, 0 to 20mA or 4 to 20mA signal to other devices such as chart recorders or data loggers. The fully isolated output can be scaled for any portion of the display range e.g. 4 to 20 mA = 500.00 to 800.00 (Litres/m). The analogue output can be configured to re-transmit rate, time or totalised (6 LSD) values.

TRACKER 280 CONFIGURATION



The instrument can be set up using the front panel buttons. The Tracker 280 prompts the user for each set-up parameter in an easy to use menu system. Configuration can be password protected to avoid unauthorised access. A Windows compatible software program is also available for set-up, configuration storage and down-loading to and from the Tracker 280. The RS422/485 serial communications interface is available as standard on all Tracker 280 models.

Tracker 280 Specification

Display

Type: 14.2mm high brightness red LED (green option)
Range: 6 digit (-199999 to 999999)
Resolution: Selectable for real time and totalled values
Update rate: 2, 4 or 10 per second (programmable)
- Also dependant on input rate (timer modes)

Inputs

Two inputs, each configurable for: AC magnetic pickup, contact closure, TTL logic and (NPN/ PNP)

Measurement: Up to 150Khz

Time base/measurement accuracy: Better than 100ppm

Pulse/frequency: User scaling for both channels. Adjustable gate time.

Isolated to all other inputs and outputs except for the status inputs and excitation supplies. Not isolated between input channels

User linearisation: 8 point per channel, for frequency and timing modes

Transducer Supplies

5 or 12VDC up to 100mA. Not isolated to the signal inputs

Measurement Modes

Count (6 or 12 digit) and totalisation, up/down and quadrature count, dependent on the phase or state of channel B. Frequency and timing measurement with integrated totalisation. Scaling to engineering units for all modes (e.g. Pulse rate to rpm, time period to mph or kph etc.).

Maths Functions

Pre-set, Tare or Zero (programmable), Max/Min memory, Ch1 - Ch2, Ch1+Ch2, count up/down, Elapsed Time, Totalise Time, Average Times, Total Period of a Cycle Time, Ratio of a Period, Ratio of Ch1 v Ch2.

Front Panel Function Buttons & Status (Logic) Inputs:

2 x buttons & 2 x status inputs, each user programmable for the following functions: display zero/reset (to a pre-set value), display hold, count start/stop, lamp test, display max, display min, display average, alarm acknowledge, alarm inhibit, display most/least significant totalled value, display rate/total toggle, analogue output hold*, keyboard inhibit*.

* Status inputs only

Safety and EMC

Safety: EN61010
Susceptibility: EN50082-2
Emissions: EN50081-1
CE Certified 2000



PM INSTRUMENTATION

59 rue Emile Deschanel,
92400 Courbevoie, France

Tel : 01 46 91 93 30

Fax : 01 46 91 93 39

Web : www.pm-instrumentation.com

Analogue Output

Output: 0-10v , 0-20mA or 4-20mA (programmable). Fully scalable
Isolation: 500VDC/peak AC
Maximum output: 22mA (18V)
Temperature drift: <150ppm
Accuracy: 0.2% of span (worst case), 0.1% typical @ 25°C ambient
Load: 0 - 900 Ohms (mA output)
Resolution: 0.05% (5mV/0.01mA)
Maximum voltage output: 11V @ 22mA)
Maximum current output: 22mA @ 18V
Programmable output filter
Can transmit a displayed value or maths derived value

Alarm Relays (T284)

Relays 1 & 2: Change over contacts
Rating: 1 Amp @ 250VAC, 5 Amp @ 30VDC

Alarm TTL Outputs (T285)

4 off, TTL open collector outputs

Serial Communications

Interface Type: RS422/485, 2 or 4-wire multidrop
Isolation: 500VDC/peak AC
Speed: 1200, 2400, 4800 or 9600 baud
Parity: Odd, even or none
Stop bits: 1 or 2
Protocols: User selectable for MODBUS™ RTU (J-BUS), MODBUS™ ASCII and DTPI (Data Track Process Instruments)

Physical/Mechanical

Front panel: Protection to IP65
Dimensions (mm): 48(H) x 96(W) x 173(D)
Panel cut-out (mm): 44(H) x 92(W)
Weight: 0.4Kg (max), packed weight 0.55Kg

Environmental

Temperature: 10-50°C operating, -10 to 70°C storage
Humidity: 0-95% RH non condensing

Ordering Code

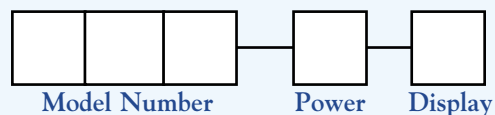

Tracker 283 Timer Counter

Tracker 284 Timer Counter with Dual Alarm Relays

Tracker 285 Timer Counter with 4 TTL Alarm Outputs

Power 1 = 90 to 256VAC 50 or 60Hz, 2 = 24VAC/DC

Display R = Red G = Green

Example 284-1-G

Tracker 284 Timer Counter with
Mains Supply and Green Display